

## 10 Channel Multi Module

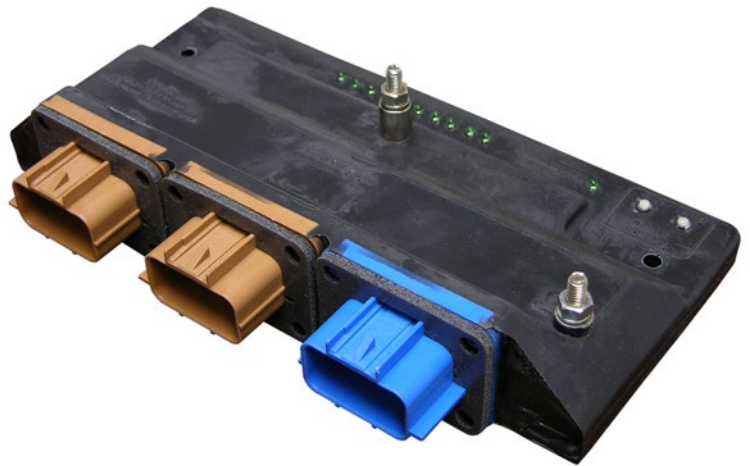

### Introduction

The E-Plex® 436MMX series is a 10 channel DC power distribution module. Eight channels are intended for lighting/resistive loads handling up to 8 A each. Two channels are capable of driving lighting/resistive loads up to 15 A each. The entire module is rated at 60 A max. All channels have built in dimming providing a flexible solution for lighting without requiring additional external dimming hardware.

The 436MMX incorporates thermal, short circuit, and programmable overload protection in order to safeguard the module against very rare or severe conditions. When E-Plex is not present, local electronic overrides capabilities allow independent operation of the device loads which can be used for testing and verification during installation.

### Key Features

- 10 channels of PWM dimming (60 amps total).
- 8 channels of 8 amp lighting / resistive loads.
- 2 channels of 15 amp lighting / resistive loads.
- Status LED's for each channel.
- Thermal, short circuit, and programmable overload protection.
- Local electronic override capabilities.
- Reverse battery protected.
- LEN value 2.

### Design Specifications

- Shock: Mil Std 202 Method 213 test condition 1.
- Vibration: Tested to Lloyds Register Approval Vibration Test 2.
- Transient voltage suppression : EN6100-6-1.
- Moisture resistance: IP66.
- PCB characteristics: UL94V-0.
- Power distribution: UL 1077 compliant (except high-voltage dielectric test).
- Ignition protection: UL 1500 compliant.
- Salt spray: Tested to Lloyds Register Approval Salt Spray Test.
- Operating Temperature: -40°C to 60°C.
- Storage Temperature: -40°C to 85°C.
- Operating Humidity: 0% to 100% (condensing).
- Weight: 1.65 lb (750g).

## Electrical Specifications

Description		Minimum	Nominal	Maximum	Absolute Maximum (Surge)
Voltage		7 VDC	12/24 VDC	32 VDC	45 VDC
Current, Total		0.025 A	30 A	60 A <sup>1</sup>	160 A <sup>2</sup>
Current, per channel continuous	Channels 1-4, 7-10 (resistive/lighting)	0	8 A <sup>11</sup>	8 A <sup>11</sup>	-
	Channels 5 and 6 (resistive/lighting)	0	12 A	15 A	-
Current, per channel intermittent duty <sup>3</sup>	Channels 1-4, 7-10 (resistive/lighting)	0	-	10A	-
	Channels 5 and 6 (resistive/lighting)	0	-	20 A	-
Current, per channel in rush capable	Channels 1-4, 7-10 (resistive/lighting)	-	-	80 A <sup>4</sup>	-
	Channels 5 and 6 (resistive/lighting)	-	-	80 A <sup>4</sup>	-
Input low threshold <sup>9</sup>		0 V	-	3.5 V	-
Input high threshold <sup>9</sup>		4.5 V	-	32 V	-
Lead inductance <sup>10</sup>		0	-	100 $\mu$ H <sup>8</sup>	-
Load inductance <sup>7</sup>	Channels 1-4, 7-10 (resistive/lighting)	0	-	20 $\mu$ H	-
	Channels 5 and 6 (resistive/lighting)	0	-	20 $\mu$ H	-
PWM frequency <sup>6</sup>		0 Hz	122 Hz	-	-
Output Impedance <sup>5</sup>		10 m $\Omega$	12 m $\Omega$	14 m $\Omega$	-

The supply to the module should be protected by a fuse or circuit breaker, 63A maximum. This module should not be used for inductive or motor loads.

## Trip Speed Characteristics

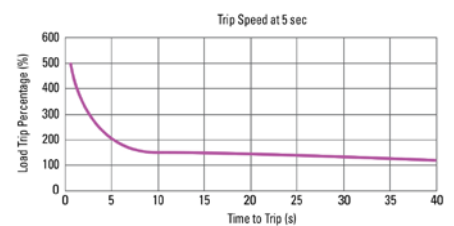
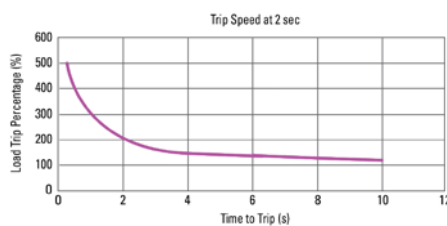
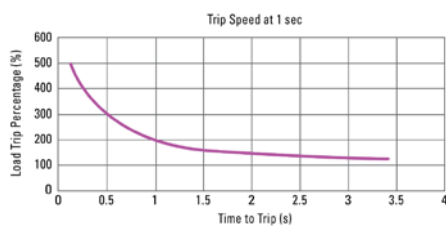

### NOTES:

- De-rate max current by 0.2 A per °C above ambient, 25°C.
- Measured at 8.3 ms single half sine wave. (JEDEC Method).
- Duty cycle at 1 minute on time, 5 minutes off. Trip delay must be set to maximum rating.
- Single pulse only.
- Measured at 10 A load.
- PWM not recommended for motor loads unless factory authorized.
- For load resistance greater than 2 ohms load inductance is unlimited.
- Specified as 50 feet of 2 AWG (43 mm<sup>2</sup>) wires with a 6 inch diameter spool for both power and ground.
- For a channel configured as an input this specifies the turn-on/off threshold impedance @ 50K.
- 100 feet maximum wiring from battery.
- Can support higher amperage depending on in-rush.

## Wiring Specifications

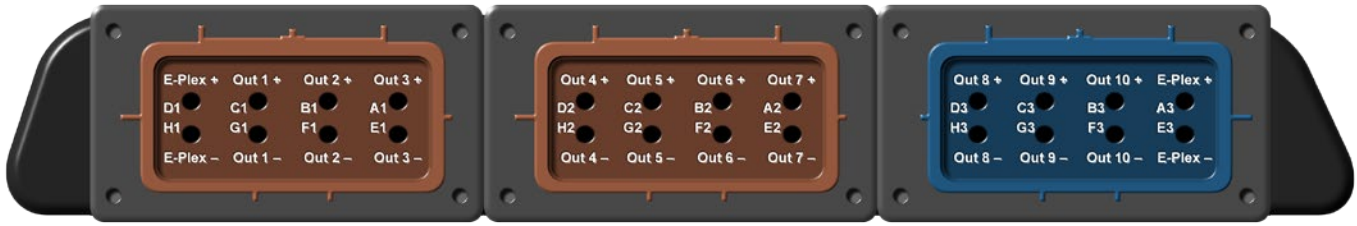

Connector 1	
Pin #	Pin Description
A1	Solid State Output 3
E1	Output 3 Return
B1	Solid State Output 2
F1	Output 2 Return
C1	Solid State Output 1
G1	Output 1 Return
D1	E-Plex Data Bus +
H1	E-Plex Data Bus -

Connector 2	
Pin #	Pin Description
A2	Solid State Output 7
E2	Output 7 Return
B2	Solid State Output 6
F2	Output 6 Return
C2	Solid State Output 5
G2	Output 5 Return
D2	Solid State Output 4
H2	Output 4 Return

Connector 3	
Pin #	Pin Description
A3	E-Plex Data Bus +
E3	E-Plex Data Bus -
B3	Solid State Output 10
F3	Output 10 Return
C3	Solid State Output 9
G3	Output 9 Return
D3	Solid State Output 8
E2	Output 8 Return

*M5-T1 Battery Power*

*M5-T2 Battery Return*

### Outputs and Returns:

Channels 1-4, 7-10: 0 to 5A, 7-32VDC (Resistive Loads).

Channels 5&6: 0 to 15A, 7-32VDC (Resistive Loads).

All outputs are PWM capable and may be used to dim lighting loads.

Battery Power (+): Up to 60A, 7-32VDC.

### Status LEDs:

ON - Channels 1-10 indicates Load ON, E-Plex channel indicates module responding.

OFF - Channels 1-10 indicates Load OFF, E-Plex channel indicates module not responding 10.

BLINKING - Channels 1-10 indicates Load FAULT, E-Plex channel indicates module responding.

Pressing channel select in Manual Mode, LED will blink when channel is active.

Power / Battery Connections: Must be fused to a maximum of 63A. Maximum wire size should be sized based on upstream fuse. When connecting the power source to the power studs on the module, torque the M5 hex nuts should be torqued to 20~22 in lb or 250~280 n-m after installing the battery terminals to the studs. Failure to properly torque hex nuts may result in intermittent operation due to terminals loosening over time.

Note: External surge suppression is required when the module battery supply cable is longer than 50'.

Reversed Battery Conditions: The loads will turn on, but no damage will occur to the module if disconnected within 1 minute. (Under nominal operating load conditions).

Pin Specifications

Cable Range AWG (mm <sup>2</sup> )		Female Terminal	Terminal Insulation Range	Seal Insulation Range	Seal P/N
18-16	(1.0-0.75 mm <sup>2</sup> )	15304716	1.70-2.25 mm	1.20-1.85 mm	15366063
				1.85-2.25 mm	15356064
16-12	(2.50-1.50 mm <sup>2</sup> )	15304717	2.20-3.00 mm	2.09-2.66 mm	15366061
				2.70-3.2 mm	15336674

Typical Wiring Diagram

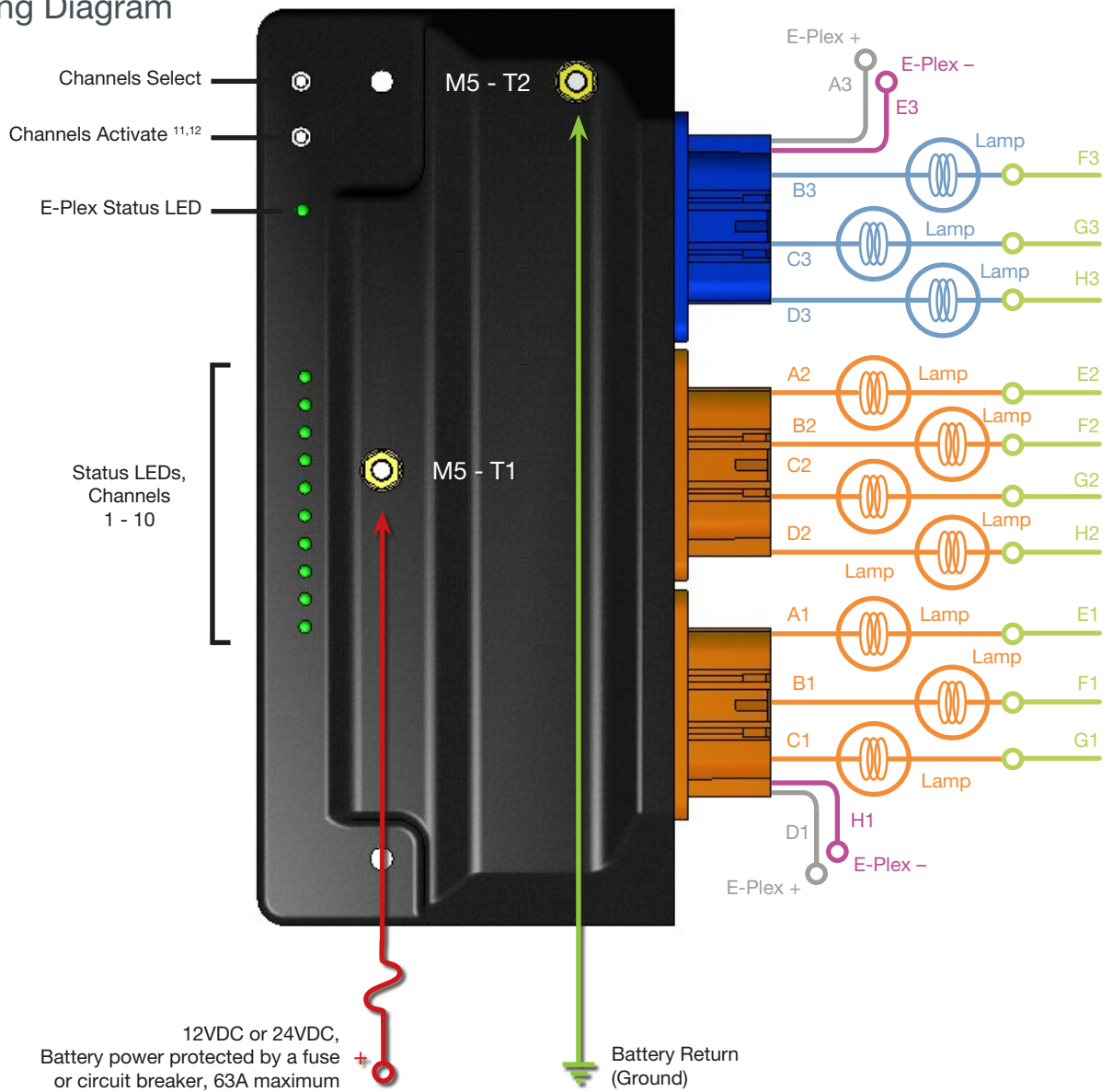

NOTES:

11. Manual override switches are meant to be used as a local electronic manual override for emergency situations only.

## Mechanical Specifications

Screw assembly to a flat mounting surface in two places, as shown in the illustration.

## Mechanical Specifications

**Metric fasteners:** Use M5 size screw, M5 split lock washer and M5 washer. Torque to 250~280 N-cm. Do not exceed this torque as it could cause damage to the electronics.

**Imperial (English) fasteners:** Use #10 size screw, #10 split lock washer, #10 washer. Torque to 20~22 in-lb. Do not exceed this torque as it could cause damage to the electronics.

## Mechanical Specifications

### Connectors:

Connectors 1, 2 - Brown: Mates to Delphi P/N 15317308

Connector 3 - Blue: Mates to Delphi P/N 15317304

### Cavity Plug:

Delphi P/N 12059168

### Power Stud Connections:

M5 nickel plated brass

## Ordering Information

Description	E-Plex Part Number
436MMX Series - 10 Channel Multi Module	EP-SW-IO-10CH-436MMX

## Dimensional Diagram

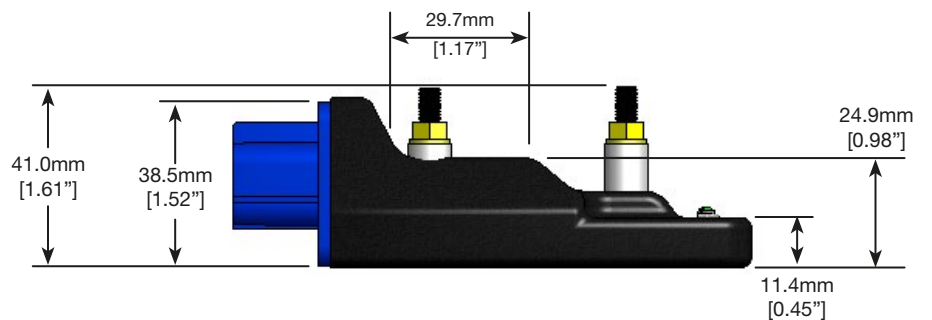
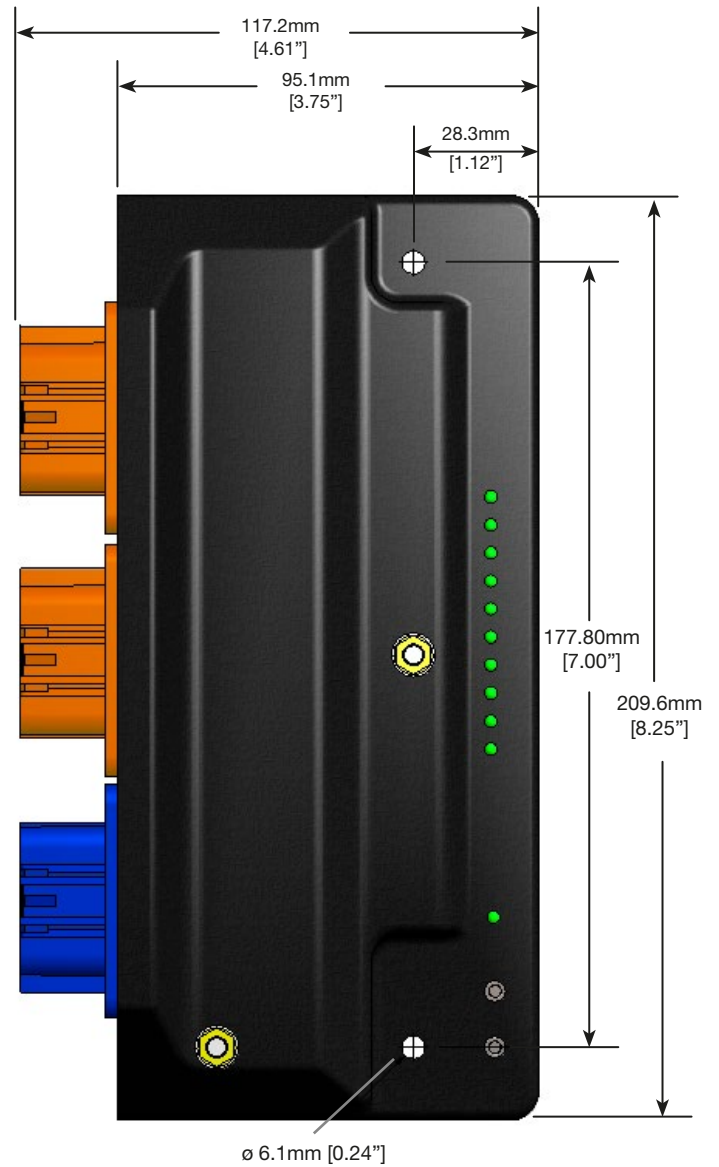



52 – 54 Riverside, Sir Thomas Longley Road, Medway City Estate, Rochester, Kent ME2 4DP  
tel: +44 (0)1634 711622 fax: +44 (0)1634 290773

email: [sales@e-plex.co](mailto:sales@e-plex.co)  
web: [www.e-plex.co](http://www.e-plex.co)

Important Notice: E-Plex Ltd. (E-Plex) reserves the right to make changes to or discontinue any product or service identified in this publication without notice. E-Plex advises its customers to obtain the latest version of the relevant information to verify, before placing any orders, that the information being relied upon is current. E-Plex assumes no responsibility for infringement of patents or rights of others based on E-Plex applications assistance or product specifications since E-Plex does not possess full access concerning the use or application of customers' products. E-Plex also assumes no responsibility for customers' product designs.